

Translation of the original assembly and operating instructions

930010-04-6-50

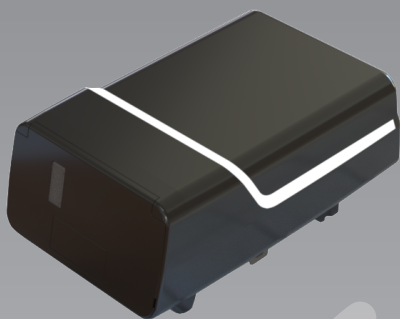

**B-1200 II**

03.2026

Door drive

# Contents

<b>1 General information</b> .....	<b>3</b>	5.10 Cycle counter .....	20
1.1 Contents and intended audience .....	3	<b>6 Initial operation</b> .....	<b>20</b>
1.2 Pictograms and signal words .....	3	<b>7 Operation</b> .....	<b>21</b>
1.3 Hazard symbols.....	3	7.1 Safety instructions for operation .....	21
1.4 Further notice and information symbols .....	3	7.2 Opening or closing the garage door (in normal operation mode) .....	21
<b>2 Safety</b> .....	<b>4</b>	7.3 Manually opening or closing the garage door.....	21
2.1 Intended use.....	4	7.4 Moving the garage door specifically into the OPEN or CLOSE position (further operating modes) .....	22
2.2 Foreseeable misuse .....	4	7.5 Determining the radio module type .....	22
2.3 Personnel qualifications.....	4	<b>8 Errors and faults</b> .....	<b>23</b>
2.4 Potential hazards associated with the product.....	5	8.1 Troubleshooting .....	23
<b>3 Product description</b> .....	<b>6</b>	8.2 Diagnostic display .....	24
3.1 General product overview .....	6	<b>9 Maintenance / checks</b> .....	<b>25</b>
3.2 Technical data .....	7	9.1 Notes on maintenance / checks .....	25
<b>4 Assembly and installation</b> .....	<b>7</b>	9.2 Monthly monitoring the force limits .....	25
4.1 Preparing for installation .....	7	9.3 Check lists.....	26
4.2 Mounting the garage door drive .....	8	<b>10 Cleaning / care</b> .....	<b>29</b>
4.3 Electrical connection of further components (accessory) .....	9	<b>11 Disassembly / disposal</b> .....	<b>29</b>
4.4 TTZ guideline - Burglar resistance for garage doors.....	11	11.1 Disassembly .....	29
<b>5 Programming the drive</b> .....	<b>12</b>	11.2 Disposal .....	29
5.1 Preparation.....	12	<b>12 Warranty terms</b> .....	<b>29</b>
5.2 Basic programming .....	12	<b>13 Declaration of conformity and incorporation</b> .....	<b>30</b>
5.3 Program the hand-held transmitter .....	12	13.1 Declaration of Incorporation in accordance with the EC Machinery Directive 2006/42/EC .....	30
5.4 Menu 3 + Menu 4: Setting the end positions .....	14	13.2 Declaration of Conformity according to Directive 2014/53/EU .....	30
5.5 Force learning cycle.....	14		
5.6 Checking the force limits .....	15		
5.7 Special settings.....	15		
5.8 Advanced special settings .....	18		
5.9 Restoring the factory settings .....	20		

EN Copyright and disclaimer

© 2026 TORMATIC®

No part of this document may be reproduced, distributed, or transmitted in any form or by any means, electronically or mechanically, including photocopying and recording for any purpose, without the express written authorization of TORMATIC®. Subject to technical modifications. – Variations possible. – The scope of delivery depends on the respective product configuration.

# 1 General information

## 1.1 Contents and intended audience

These assembly and operating instructions describe the garage door drive of the B-1204 series (hereinafter referred to as "product"). The assembly and operating instructions are intended for technicians that install and maintain the product, and for consumers that use the product on a daily base.

These assembly and operating instructions only refer to the control via hand-held transmitter. Other devices work in the same way.

### 1.1.1 Illustrations

The illustrations in these assembly and operating instructions help you to better understand the descriptions and procedures. The illustrations only serve as examples and may deviate slightly from your product's actual appearance.

## 1.2 Pictograms and signal words

Important information in these assembly and operating instructions is marked with the following pictograms.

### **DANGER**

#### **DANGER**

... indicates a hazardous situation which, if not avoided, will result in death or serious injury.

### **WARNING**

#### **WARNING**

... indicates a hazardous situation which, if not avoided, could result in death or serious injury.

### **CAUTION**

#### **CAUTION**

... indicates a hazardous situation which, if not avoided, could result in minor or moderate injury.

## 1.3 Hazard symbols



### **Danger!**

This sign indicates an immediate risk of the death or injury of persons



### **Warning of electrical voltage!**

This symbol indicates dangers to the life and health of persons due to electrical voltage when handling the system.



### **Crush hazard to limbs !**

This sign indicates hazardous situations with a limb crush hazard.



### **Crush hazard to the whole body!**

This sign indicates hazardous situations with a crush hazard to the whole body.

## 1.4 Further notice and information symbols

### **NOTICE**

#### **NOTICE**

... indicates important information (e.g. material damage), but does not indicate dangers.



### **Info!**

Information marked with this symbol helps you to carry out your tasks quickly and safely.



### **Observe instructions**

This symbol indicates that you must observe the assembly and operating instructions.



This symbol indicates that the garage door drive is designed for a cycle sequence of 3 cycles per hour.

**1**

Refers to a graphic of the corresponding assembly step on the A3 Instruction poster and to the "Connection diagram overview" chapter.

## 2 Safety

Observe the following safety information:

### WARNING

#### Risk of injury when disregarding the safety information and instructions!

Failure to observe the safety information and instructions can cause an electric shock, fire and / or severe injuries.

- Following the safety information and directives given in these assembly and operating instructions helps to avoid personal injuries and material damage while working on and with the product.
- Read and comply with all safety information and instructions.
- All guidelines and instructions for the garage door drive (installation, operation and maintenance, etc.) must be followed.
- Only use the product for the intended use as mentioned in these instructions.
- Keep all safety information and instructions for future reference.
- Installation work may only be carried out by qualified technicians.
- Observe all applicable national regulations.
- Never make any modifications or changes to the product that have not been expressly approved by the manufacturer.
- Only use genuine spare parts of the manufacturer. Incorrect or faulty spare parts can cause damage, malfunctions or even a total failure of the product.
- This product can be used by children aged from 8 years and above and persons with reduced physical, sensory or mental capabilities or lack of experience and knowledge if they have been given supervision or instruction concerning use of the appliance in a safe way and understand the hazards involved.
- Children shall not play with the appliance. Cleaning and maintenance shall not be made by children without supervision.
- Failure to comply with the safety information and directives given in these instructions or with the accident prevention regulations and general safety regulations relevant to the field of application shall exempt the manufacturer or its representative from all liability and shall render any damage claims null and void.

### 2.1 Intended use

The product is designed exclusively for opening and closing spring-balanced or weight-balanced garage doors. It may not be used for garage doors without spring-balancing or weight-balancing mechanisms.

Never make any modifications or changes to the product that have not been expressly approved by the manufacturer.

### 2.2 Foreseeable misuse

Any use other than described in chapter Intended use is regarded as reasonably foreseeable misuse. This includes but is not limited to:

- using the product as a drive for sliding door constructions
- using the product for garage doors without spring-balancing or weight-balancing mechanisms

Any damage or injury as a result of reasonably foreseeable misuse or of not following the assembly and operating instructions will render the manufacturer's liability null and void.

### 2.3 Personnel qualifications

Only personnel who are familiar with these assembly and operating instructions and the dangers associated with handling this product may use this product. The individual activities require different personnel qualifications listed in the following table.

Activities	Operating personnel	Skilled workers <sup>a</sup> with relevant training, e.g. industrial mechanic	Skilled electrician <sup>b</sup>
Installation, assembly, commissioning		X	X
Electrical installation			X
Operation	X		
Cleaning	X		
Maintenance	X	X	X
Work on the electrical system (troubleshooting, repair & deinstallation)			X
Work on the mechanical system (troubleshooting & repair)		X	
Disposal	X	X	X

**a.** A skilled worker is a person who, due to his/her professional training, his knowledge and experience as well as due to his/her knowledge of the relevant regulations, is able to judge the work assigned to him/her as well as to identify possible hazards.

**b.** Electrically skilled personnel must be able to read and understand electric circuit diagrams, to put electrical systems into service and to maintain them, to wire control cabinets, to ensure the functionality of electrical components and to identify possible hazards from electrical and electronic systems.

## 2.4 Potential hazards associated with the product

The product has undergone a risk assessment. The product's design and construction, which are based on this risk assessment, correspond to the current state-of-the-art.

The product is safe to operate when used as intended. Nevertheless, residual risks remain.

### **DANGER**



#### **Hazardous voltage**

Fatal electric shock when touching live parts. Observe the following safety rules when working on the electrical system:

1. Disconnect from the mains
2. Secure against inadvertent switch-on.
3. Verify de-energised state.

Work on the electrical system may only be performed by skilled electricians or instructed persons working under the direction and supervision of a skilled electrician in accordance with the electrotechnical rules and directives.

### **WARNING**



#### **Crush and impact hazard at the garage door!**

During the force learning cycle, the drive automatically learns the normal mechanical force required to open and close the garage door. Force limits are deactivated until the conclusion of the learning cycle.



The door movement will not be stopped by an obstruction!

- Keep a sufficient distance from the entire path of motion of the garage door!
- Only interrupt the procedure in case of danger.

# 3 Product description

## 3.1 General product overview

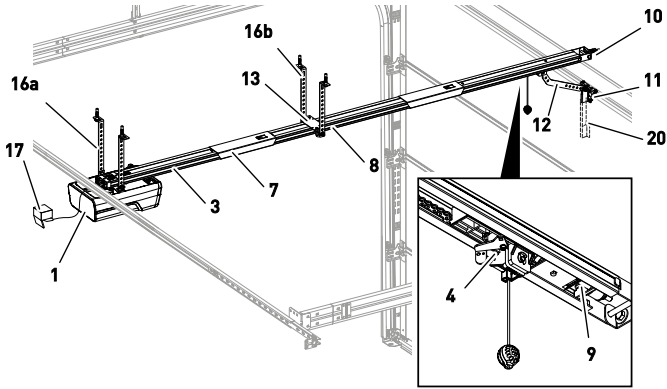

Fig. 1: Product overview – assembled

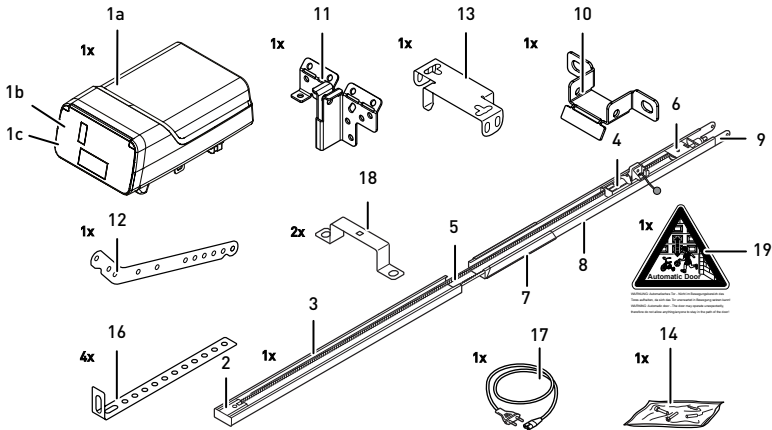

Fig. 2: Product overview – individual parts

- |     |                                 |      |   |
|-----|---------------------------------|------|---|
| 1a. | Drive head                      | 10.  | Wall bracket                            |
| 1b. | Service flap                    | 11.  | Door connector attachment               |
| 1c. | Rating plate                    | 12.  | Linking bar                             |
| 2.  | Pinion*                         | 13.  | Central support                         |
| 3.  | Rail (model example) drive side | 14.  | Bag of screws                           |
| 4.  | Carriage*                       | 16a. | Ceiling mountings on drive head         |
| 5.  | Toothed belt or chain*          | 16b. | Support straps track                    |
| 6.  | Deflection roller*              | 17.  | Mains cable (depending on the model)*   |
| 7.  | Rail connector (model example)* | 18.  | Mounting bracket                        |
| 8.  | Rail (model example) door side* | 19.  | Warning label                           |
| 9.  | Tensioner*                      | 20.  | Telescopic fitting for sectional doors* |

\*Optional

In the factory setting, the service flap of the drive is not pre-assembled. The scope of delivery is determined by the product configuration.

## 3.2 Technical data

General	
Control unit:	B-1204
Operating mode:	Pulsed operation, remote-controlled
Max. door size:	18 m <sup>2</sup>
Max. door weight:	200 kg (sectional door) / 280 kg
Rated load capacity:	360 N
Max. load capacity:	1200 N

Electrical data	
Rated voltage:	230 V~ (alternating current)
Frequency:	50 Hz
Protection class:	I (protective earth)
Power consumption standby:	< 0.8 W
Power consumption max. operation:	440 W
Max. time until standby:	240 seconds
24 V output (DC):	12 W
230 V output (AC):	Max. 250 W
Lighting LED:	7 W

Cycles	
Max. cycles / hour:	12
Max. cycles / day:	150
Max. cycles total:	50000

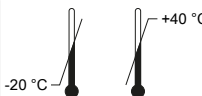
Surroundings	
Type of protection:	IP20, for dry rooms only
Sound level:	< 70 dBA
Temperature range:	

Safety according to EN 13849-1	
Input STOP-A:	Cat. 2 / PL = C
Input STOP-B:	Cat. 2 / PL = C

Radio module depending on the features	
TRX-433	f = 433.92 MHz, P <sub>erp</sub> < 10 mW, RX Cat. = 1.5
TRX-868	f = 868.3 MHz, P <sub>erp</sub> < 25 mW, RX Cat. = 1.5
E43-M	f = 433.92 MHz, RX Cat. = 1.5
Supported protocols:	AES / Keeloq / Multibit

Manufacturer	
Company:	Novoferm tormatic GmbH
Address:	Eisenhüttenweg 6 44145 Dortmund Germany

## 4 Assembly and installation

### 4.1 Preparing for installation

#### CAUTION



#### Impact or falling hazard!

- Persons can be hit or knocked over by the garage door.
- Ensure that the door does not project into public footpaths or roads during installation.

#### CAUTION



#### Crush hazard!

- Some parts of the latching devices on the existing garage door can form pinch or shear points.
- When you convert the garage door to an automatic drive for the first time, the existing locking mechanisms have to be dismantled prior to the assembly.

#### NOTICE

Check the supplied screws and wall plugs to make sure that they are suitable for the structural condition on the installation site.

- A socket must be installed on site for power supply. The supplied power cable is approx. 1.2 m long.
- Check the door for stability. If necessary, tighten the screws and nuts at the door.
- Check the door for correct movement. Lubricate shafts and bearings. Additionally, also check the pretension of the springs, and adjust if necessary.
- Dismantle any door latches (bolt plate and catches).
- For garages without a second entrance, an emergency release (accessory) is required.
- For garages with a wicket door, install the wicket door contact.
- Stationary control devices must be installed at a height of at least 1.5 m and within sight of the door, but away from moving parts.
- After installation, make sure that no parts of the door protrude into public footpaths or roads.

## 4.2 Mounting the garage door drive

Follow the instructions as shown on the A3 Instruction poster.

### 1. Inserting the rail

Fold out the rail (3 and 8) to its full length. Push the rail connector (7) centrally over the joints. Re-tension the chain or the toothed belt if necessary (fig. **1a**).

Fix the rail connector by bending the two tabs upwards (fig. **1b**).

### 2. Installing the mounting brackets

Mount the drive head (1) to the rail (3, fig. **2**) using the mounting brackets (18).

### 3. Installing the centre suspension

Mount the centre suspension (13) to the rail (fig. **3**).

### 4. Mounting the connector attachment

Mount the connector attachment (11) to the garage door (fig. **4**).

### 5. Mounting the wall bracket

Establish the clearance at opening or closing of the garage door. Install the wall bracket 25 mm above the highest point of the door (10, fig. **5**).

### 6. Mounting the rail and ceiling mountings

Mount the rail (3 and 8) to the wall bracket (10, fig. **6a**). Mount the ceiling mountings (16) to the centre bracket (13) and to the drive head (1, fig. **6c** and fig. **6d**). Then, mount the ceiling mountings (16) to the ceiling.

### 7. Connecting the linking bar

Connect the linking bar (12) between the carriage (4) and the garage door connector attachment (11, fig. **7**).

### 8. Routing the antenna

Take the antenna out of the holder and feed it outwards through the feed-through. If necessary, punch through the feed-through with a suitable tool (e.g. a pointed / sharp pencil) beforehand (fig. **8**).

### 9. Mounting the service flap

Place the service flap (1b) on the opening on the drive head and press the service flap down on both sides until it engages (fig. **9**).

## 10. Warning sticker

Attach the warning sticker (19) to the inside of the garage door so that it is easily visible (fig. **10**).



WARNING: Automatic door – Do not stand in the movement area of the door, because it may start unexpectedly!

## 11. Programming

For programming, fold down the service flap (1b) on the drive head (fig. **11**).

### 4.3 Electrical connection of further components (accessory)

If necessary, open the service flap (1b) to access the connection terminals on the drive head (1a).

#### **⚠ DANGER**



#### **Hazardous voltage!**

Fatal electric shock when touching live parts.

Always pull out the mains plug before working on the drive!

#### 4.3.1 Connection diagram overview

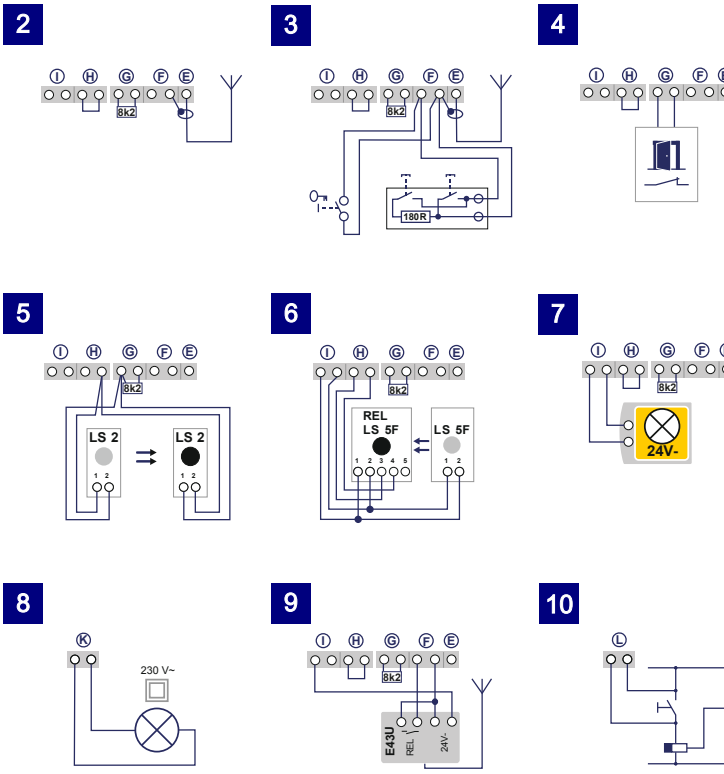
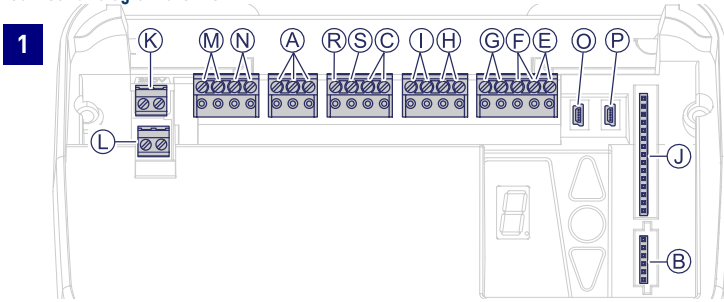

11

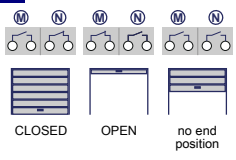

12

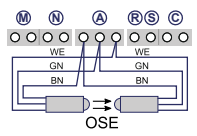

13

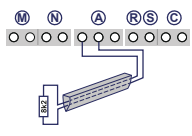

14

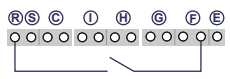

15

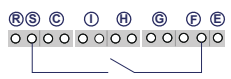

16

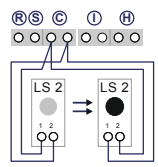

17

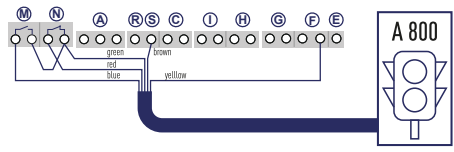

No.	Terminal	Description
1		Overview of terminal assignment at the drive head
1	J	Plug base for radio receiver
	O/P	2 x connection for mobility module or radio closing edge (accessory)
	B	Slot for Bluetooth module (accessory)
2	E	Connector for antenna. When using an external antenna, the shield must be placed on the terminal that is adjacent on the left (F).
3	F	Connector for external pulse generator (accessories, e.g. key switch or code keypad)
4	G	Input (STOP-A) for wicket door contact (accessory) or emergency stop. The drive is stopped or the start-up is suppressed via this input (see also Special settings, Menu H: STOP-A settings (wicket door contact)).
5	G/H	Input for photoelectric sensor LS2. For the use of other photoelectric sensors, please refer to the connection points of the photoelectric sensor manual.
6	I/H	Input (STOP-B) 4-wire photoelectric sensor (e.g. LS 5F). This input activates the automatic reversal of the drive during closing.
7	I	Voltage supply 24 V DC max. 500 mA (switched) e.g. for 24 V signal light (accessory) <b>Caution!</b> Do not connect a push button!
8	K	Output 230 V for external, protectively insulated lighting or signal light (protection class II, max. 250 W) (accessory)
9	F/I	Voltage supply 24 V DC max. 500 mA (permanent) e.g. for an external radio receiver (accessory)
10	L	Connection for staircase control device, potential-free relay contact, 250 V AC / 5 A
11	M/N	Status message door OPEN Connection for traffic light control, potential-free relay contact 120 V AC / 0.5 A or 24 V DC / 1 A Status message door CLOSED Connection for traffic light control, potential-free relay contact 120 V AC / 0.5 A or 24 V DC / 1 A

No.	Terminal	Description
12 / 13	A	Input for optical closing edge safety device OSE (24 V supply) or electrical contact strip 8k2 (see also special settings, menu F: Closing edge safety device settings)
14	R	Input for targeted door movement (see menu o)
15	S	Input for targeted door movement (see menu E)
16	C	Input for an additional photoelectric sensor LS2 (see menu c). The photoelectric sensor must not be installed in the frame.
17	M/N	Connection for traffic light control (menu E, value 5 default setting)

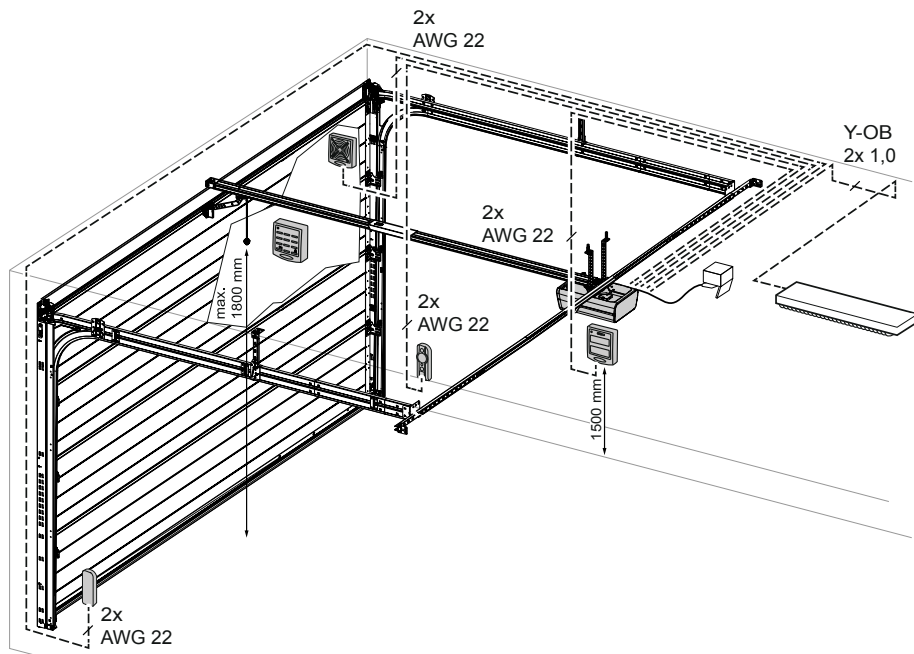

Fig. 3: Example installation of accessories

#### 4.3.2 Pulse generator and external safety devices



In situations of increased requirements in terms of personal protection, we recommend, in addition to the internal power limitation of the drive, the installation of a 2-wire photoelectric sensor. The installation of a 4-wire photoelectric sensor serves purely for the protection of property. For further information on our range of accessories, please refer to our sales literature or consult your specialist dealer.

#### 4.4 TTZ guideline - Burglar resistance for garage doors

In order to comply with the TTZ guideline, corresponding accessories are necessary for increased burglar protection. These accessories can be ordered separately. Please use our Secü Kit and follow the instructions WN 020690-45-5-32. Also follow the instructions WN 902004-21-6-50 as installation instructions for TTZ guideline burglary resistance for garage doors.

#### NOTICE

Before using the drive for the first time, test it to make sure that it is working properly and safely (see chapter Maintenance / Checks)

## 5 Programming the drive

### 5.1 Preparation

1. Make sure that the garage door is connected to the drive head.
2. Make sure that the antenna is correctly positioned (see chapter "Mounting the garage door drive").
3. Make sure that you have all hand-held transmitters for this garage door at hand.
4. Open the cover at the drive head.
5. Connect the drive head to the mains socket.

### 5.2 Basic programming

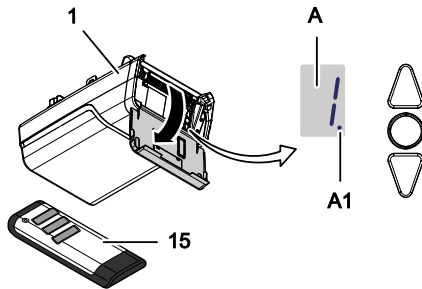

Fig. 4: Control elements

A Digital display

A1 Digital point (numerical display)

1 Drive

15 Hand-held transmitter

▽ Programming navigation button

△ Programming navigation button  
Start button door OPEN/door CLOSE

○ Programming button

Programming the control unit is menu-driven.

- Pressing the programming button ○ opens the menu. The digit on the display (A) indicates the menu step.
- By pressing the programming button ○ repeatedly you can skip menu steps.
- After approx. 2 seconds, the display (A) starts flashing and the setting can be changed using the △ and ▽ buttons.
- By pressing the programming button ○, the set value is stored.
- To quit the menu, press the programming button ○ repeatedly until "0" is displayed again or until the display goes out.
- Outside the menu (no display), the △ button can be used to generate a start pulse.

Information on further and/or special settings can be found in the chapters "Special settings" and "Advanced special settings".

### 5.3 Program the hand-held transmitter

A maximum of 100 button commands can be taught via various hand-held transmitters.

#### 5.3.1 Menu 1: Start function via the hand-held transmitter



1. Press the programming button ○ briefly once.  
⇒ Menu 1 is displayed.
2. When the display flashes, press the hand-held transmitter button 1 with which you will later start the drive until the point display (A1) on the display flashes 4 times.

#### NOTICE

Up to 100 codes can be learned.  
(Example: 50x start and 50x light).

#### 5.3.2 Menu 2: Light function via the hand-held transmitter

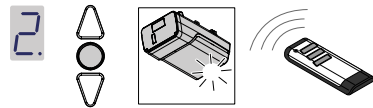

Fig. 5: Programming the light function for the hand-held transmitter

1. Press the programming button ○ briefly twice.  
⇒ Menu 2 is displayed.
2. Press the button on the hand-held transmitter to control the light until the digital point (A1) in the display flashes 4 times.

#### NOTICE

Up to 100 codes can be learned.  
(Example: 50x start and 50x light).

### 5.3.3 Menu L: Ventilation function via the hand-held transmitter

The ventilation function makes it possible to ventilate the garage. The door position for the ventilation function depends on the design of the door and is approx. 10 cm travel path of the drive. The travel path of the ventilation position cannot be changed. The garage door can be closed at any time using the hand-held transmitter. The door closes automatically after approx. 60 minutes (time cannot be changed).

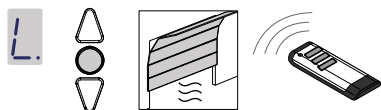

1. Press the programming button  briefly three times.  
⇒ Menu **L** is displayed.
2. Press the button on the hand-held transmitter to control the ventilation function until the digital point (A1) in the display flashes 4 times.

 Please note that this function is not available in AR mode.



#### NOTICE

Up to 100 codes can be learned.  
(Example: 50x start and 50x light).

### 5.3.4 Menu P: Partial opening function via the hand-held transmitter

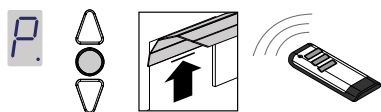
In this mode, the garage door is opened at an approximate width of 1 m.



1. Press the programming button  briefly three times.  
⇒ The value **L** is shown.
2. Press the programming button  for approx. 3 seconds.  
⇒ The value **P** is shown.
3. Press the button on the hand-held transmitter to control the partial opening function until the point display (A1) in the display flashes 4 times.



 Please note that this function is not available in AR mode.

#### NOTICE

Up to 100 codes can be learned.  
(Example: 50x start and 50x light).

### 5.3.5 Menu n: OPEN function via the hand-held transmitter





1. Press the programming button  briefly three times.  
⇒ The value **L** is shown.
2. Press the programming button  for approx. 3 seconds.  
⇒ The value **n** is shown.
3. Press the programming button  briefly once.  
⇒ The symbol **n** is displayed.
4. Press the button on the hand-held transmitter to control the OPEN function until the point display (A1) on the display flashes 4 times.

#### NOTICE

Up to 100 codes can be learned.  
(Example: 50x start and 50x light).

### 5.3.6 Menu u: CLOSE function via the hand-held transmitter



1. Press the programming button  briefly three times.  
⇒ The value **L** is shown.
2. Press the programming button  for approx. 3 seconds.  
⇒ The value **u** is shown.
3. Press the programming button  briefly twice.  
⇒ The symbol **u** is displayed.
4. Press the button on the hand-held transmitter to control the CLOSE function and keep it pressed until the point display (A1) on the display flashes 4 times.

#### NOTICE

Up to 100 codes can be learned.  
(Example: 50x start and 50x light).

### 5.3.7 Deleting all hand transmitters programmed for the drive

You can delete all hand-held transmitters programmed for the drive.

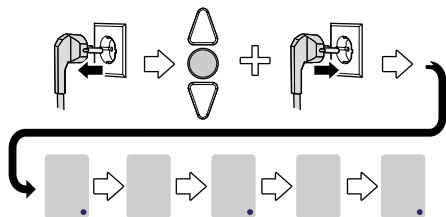

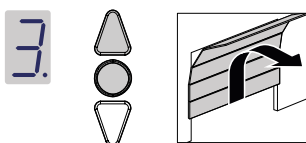





Fig. 6: Deleting all hand-held transmitters programmed for the drive

1. Pull out the mains plug of the drive head.
2. Press and hold the programming button .
3. Plug the mains plug into the mains socket while keeping the programming button  pressed.
  - ⇒ The point display A1 flashes quickly.
  - ⇒ All hand-held transmitters programmed for the drive are deleted.

### 5.4 Menu 3 + Menu 4: Setting the end positions







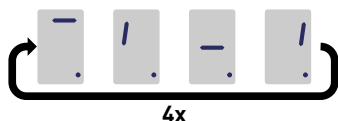

1. Keep the programming button  pressed for approx. 3 seconds.
  - ⇒ Menu  is displayed.
2. Press the  button and check if the garage door moves to the OPEN position.

#### NOTICE



If the garage door moves in the wrong direction, initiate a change of direction by keeping the programming button  pressed in for approximately 5 seconds until a chaser light appears.

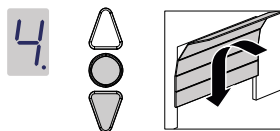

3. Keep the  button pressed until the garage door has reached the desired end position OPEN. If necessary, press the  button to correct the position.
  4. Once the garage door is in the desired end position OPEN, press the programming button .
- ⇒ Menu  is displayed.

5. When the display flashes, press and hold the  button until the garage door has reached the desired end position CLOSE. If necessary, press the  button to correct the position.



6. Once the garage door is in the desired end position CLOSE, press the programming button .
- ⇒ The number  for the force learning cycle is displayed.
7. Continue with the force learning cycle.

### 5.5 Force learning cycle

#### WARNING





#### Crush and impact hazard at the garage door!



During the force learning cycle, the drive automatically learns the normal mechanical force required to open and close the garage door. Force limits are deactivated until the conclusion of the learning cycle. The door movement will not be stopped by an obstruction!

- Keep a sufficient distance from the entire path of motion of the garage door!

#### NOTICE

- During the force learning cycle the display shows the value . Do not interrupt this procedure. After completing the force learning cycle,  on the display must disappear.
- Should the  on the display not disappear, repeat the procedure.
- The force learning cycle always starts from the end position CLOSE.
- After 5 failed attempts, "3" is displayed and you are prompted to repeat the setting of the end positions, see also "Menu 3 + Menu 4: Setting the end positions".

#### NOTICE

- We recommend selecting the according door type before carrying out the force learning cycle. To do so, please follow chapter "Menu 8: Door type setting".

#### NOTICE

- Every time the garage door springs are replaced, the force learning cycle must be carried out again.



1. Press the button or use the set hand-held transmitter. The garage door moves from the end position CLOSE to the end position OPEN.
2. Press the button again or use the set hand-held transmitter. The garage door moves from the end position OPEN to the end position CLOSE. After approximately 2 seconds, the on the display disappears.

## 5.6 Checking the force limits

### NOTICE

- After completing the force learning cycles, the force limits need to be checked.
- The force limits must be checked once a month.

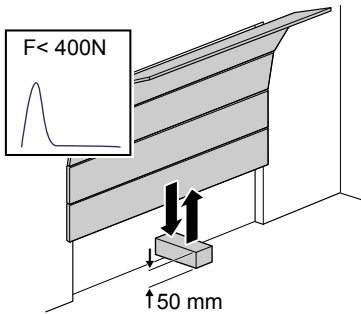

Fig. 7: Checking the force limits

1. Place a force gauge or a suitable obstruction (e.g. the drive's cardboard box) in the closing area of the door.
2. Close the garage door. The garage door moves to the end position CLOSE. When the garage door reaches the obstruction, it must stop and move back to the end position OPEN.
3. If the door can lift persons (e.g. openings greater than 50 mm or treads), the force limiting unit must also be checked in the opening direction: For additional load of the door with 20 kg of mass, the drive has to stop.

### NOTICE

If the obstruction is not detected or if the force values are not complied with, the force limit needs to be set according to chapter Menu 5 + Menu 6: Force limits for opening and closing / delete force learning cycle.

## 5.7 Special settings

### 5.7.1 Opening the "Special settings" menu

1. To open the menu for special settings, keep the programming button pressed for approximately 3 seconds.
  - ⇒ The value is shown.
2. Press the programming button again.
  - ⇒ The value is shown.
3. Keep the programming button pressed again for approximately 3 seconds.
  - ⇒ The first menu of the special settings is displayed.

### 5.7.2 Menu 5 + Menu 6: Force limits for opening and closing / delete force learning cycle

#### Changing the force limit

#### WARNING



#### Crush hazard at the door!

If the force limits are set too high, there is a risk of personal injury.



- The force on the main closing edge must not exceed 400 N for a maximum of 750 ms!





We recommend selecting the according door type in menu before carrying out the force learning cycle.

The force limit settings for the opening and closing cycle can be adapted in the menu and . Values from 0 to 8 can be set. Carry out the following steps to change the force limit:



1. Select menu .
- ⇒ After approximately 2 seconds, the display flashes and the set value for the force limit for opening appears.
2. Adjust the setting using the buttons and .
- ⇒ A high value reduces the sensitivity of the force limit.
- ⇒ A low value increases the sensitivity of the force limit.
3. Press the programming button . Menu is displayed. After approximately 2 seconds, the display flashes and the set value for the force limit for closure appears.
4. Adjust the setting using the and buttons.
5. Press the programming button .
- ⇒ Menu is displayed.

### Repeating the force learning cycle

You can additionally repeat the present force learning cycle in menu **5**. The end positions are maintained in this process and do not have to be set again. Follow the steps below to repeat the present force learning cycle:

1. Select menu **5**.  
⇒ After approximately 2 seconds, the display flashes and the set value for the force limit for opening appears.
2. Press the programming button  for 3 seconds.  
⇒ A chaser light appears and the force learning cycle is can be re-started.  
⇒ To indicate that the drive is in force learning cycle mode,  is shown on the display.
3. Carry out a force learning cycle in accordance with the instructions given in the "Force learning cycle" chapter.

### 5.7.3 Menu 7: Adjusting the light phases

1. Select menu **7**.  
⇒ After approximately 2 seconds, the display flashes and the set value for light time appears.
2. Adjust the setting using the buttons  .

Value	Light time
0	0 s (drive switches the light off directly after a drive cycle)
1	20 s
2	40 s
3*	60 s
4	90 s
5	120 s
6	150 s
7	180 s
8	210 s
9	value personalised via Bluetooth APP



\*default setting

3. Press the programming button .  
⇒ Menu **5** is displayed.

### 5.7.4 Menu 8: Door type setting

#### NOTICE

After the door type has been changed, the force learning cycle must be repeated.

1. Select menu **8**.  
⇒ After approximately 2 seconds, the display flashes and the set value appears.
2. Select the door type using the   buttons.

Value	Door type
0*	Standard / sectional door with tension spring fitting (Topspeed)
1	Double swing gate
2	Non-swinging door, Canopy
3	Swing door, tilting door, normal
4	Swing door, tilting door, sensitive running
5	Sectional door with torsion spring fitting (Topspeed)
6	Industrial door with standard fittings
7	Side section door (Topspeed)
8	Side section door with secondary closing edge
9	setting personalised via Bluetooth APP

\*default setting

3. Press the programming button .  
⇒ Menu **5** is displayed.

### 5.7.5 Menu 9: Automatic closing / single-lane control

#### WARNING



#### Crush and impact hazard at the garage door!

Automatic closing of the door poses a risk of injury to persons.

- Install a photoelectric sensor in connection with the "Automatic closing" function.

#### NOTICE

Automatic closing is aborted if the lower end position during the closing cycle is not reached due to repeated interruption of the photoelectric sensor after 5 closing processes.

"Automatic closing" has the effect that the door closes again automatically after the upper end position has been reached, following an "Open time" and the "Warning time" (if this is set in menu **4**).

The "single-lane control" function is used to control traffic in entry and exit areas. When a pulse is generated, the connected traffic light control system switches and only allows traffic to flow in one direction at a time. Please also note the setting in menu **E** with value = 5 (default setting).

- Select menu **9**.  
⇒ After approximately 2 seconds, the display flashes and shows the set value of the operating mode.
- Adjust the setting using the buttons **▲ ▼**.

Value	Automatic closing / single-lane control
0*	Switched off – no automatic closing/single-lane control (in combination with traffic light control)
1	Automatic closing switched on – a pulse always causes the door to open. When the open time and warning time have elapsed (setup menu <b>A</b> and <b>L</b> ), the door closes automatically. An interruption of the photoelectric sensor during closing causes stop and reverse direction. Interruption during opening has no effect. A pulse during the open time or warning time causes the open time and warning time to recommence from the start. An interruption of the photoelectric sensor (LS2) during the warning time also causes the open time and warning time to recommence from the start. An interruption of the photoelectric sensor (LS2) during the open time has no impact.
2	Automatic closing switched on – function as in the case of setting value 1. A pulse during the open time or warning time causes the open time and warning time to recommence from the start. An interruption of the photoelectric sensor (LS2) during the open time has the effect that the open time is terminated prematurely and the warning time is started. An interruption of the photoelectric sensor (LS2) during the warning time has the effect that the warning time commences from the start.
3	Automatic closing switched on – function as in the case of setting value 1. A pulse during the open time has the effect that the open time is terminated prematurely and the warning time is started. A pulse during the warning time has the effect that the warning time recommences. An interruption of the photoelectric sensor (LS2) during the open time has no impact. An interruption of the photoelectric sensor (LS2) during the warning time has the effect that the warning time commences from the start.
4	Single-lane control (in combination with traffic light control) with abort of the green phase when the photoelectric sensor is crossed

\*default setting

- Press the programming button **○**.  
⇒ Menu **A** is displayed.

### 5.7.6 Menu A: Open time



The menu **A** (open time) is only displayed when a value > 0 is set in the menu **9** (automatic closing).

When the door reaches the upper limit position when opening, the time for which the door remains in the upper limit position is defined by the "open time". After the time set has elapsed, the "Automatic closing" function is executed.

- Select menu **A**.  
⇒ After approximately 2 seconds, the display flashes and shows the set value of the operating mode.
- Set the desired open time using the buttons **▲ ▼**.

Value	Open time in seconds	Value	Open time in seconds
0*	10	5	150
1	30	6	180
2	60	7	210
3	90	8	240
4	120	9	setting personalised via Bluetooth APP

\*default setting

- Press the programming button **○**.  
⇒ Menu **L** is displayed.

### 5.7.7 Menu C: Warning time

The warning time specifies the time before the drive starts moving after a start signal. Furthermore, the output voltage 24 V is switched on if the TAM function is not set in menu **U** (output 24 V).



If a safety device (e.g. a photoelectric sensor) is activated during the warning time, the start process is aborted.

- Select menu **C**.  
⇒ After approximately 2 seconds, the display flashes and the set value appears.
- Adjust the setting using the buttons **▲ ▼**.

Value	Warning time in seconds	Effective in direction of movement
0*	0	
1	3	OPEN and CLOSE
2	10	OPEN and CLOSE
3	3	OPEN
4	10	OPEN
5	3	CLOSE
6	10	CLOSE
9	setting personalised via Bluetooth APP	

\*default setting

3. Press the programming button .

⇒ Menu **H** is displayed.

### 5.7.8 Menu H: STOP-A settings (wicket door contact)

1. Select menu **H**.

⇒ After approximately 2 seconds, the display flashes and the set value appears.

2. Adjust the setting using the buttons  .

Value	Description
0*	Connection of an ENS-S 8200 to terminal G (STOP-A)
1	Connection to a jumper or ENS-S 1000 to terminal G (STOP-A)

\*default setting

3. Press the programming button .

⇒ The value **1** is shown.

### 5.8 Advanced special settings

#### 5.8.1 Opening the “Advanced special settings” menu

1. To open the menu for advanced special settings, keep the programming button  pressed for approximately 3 seconds.

⇒ The value **3** is shown.

2. Press the programming button  again.

⇒ The value **4** is shown.

3. Keep the programming button  pressed again for approximately 3 seconds.

⇒ The value **5** is shown.

4. Press the programming button  repeatedly until the letter **H** is shown.

5. Keep the programming button  pressed again for approximately 3 seconds.

⇒ The first menu **U** of the advanced special settings is displayed.

#### 5.8.2 Menu U: Output 24 V

The setting in this menu indicates the time for which the output 24 V remains switched on after a door drive cycle.

1. Select menu **U**.

⇒ After approximately 2 seconds, the display flashes and the set value appears.

2. Adjust the setting using the buttons  .

Value	Switch-on time 24 V in seconds
0*	0
1	20
2	40
3	60
4	90
5	120
6	150
7	180
8	TAM (“door open message”): 24 V are switched on as long as the door is not closed
9	setting personalised via Bluetooth APP

\*default setting

3. Press the programming button .

⇒ Menu **d** is displayed.

#### 5.8.3 Menu d: Output 230 V

The setting in this menu indicates the time for which the output 230 V remains switched on after a drive cycle.

1. Select menu **d**.

⇒ After approximately 2 seconds, the display flashes and the set value appears.

2. Adjust the setting using the buttons  .

Value	Switch-on time 230 V in seconds
0	0
1	20
2	40
3*	60
4	90
5	120
6	150
7	180
8	210
9	setting personalised via Bluetooth APP

\*default setting

3. Press the programming button .

⇒ Menu **F** is displayed.

### 5.8.4 Menu F: Closing edge safety device settings

You can connect an external radio closing edge safety device (accessory) to input O or P or connect a closing edge safety device (accessory) to input A. This menu serves to set the properties of the external closing edge safety device.



#### WARNING



#### Crush and impact hazard at the garage door!

If menu values 7 and 8 are selected, the internal power control is deactivated when moving in the CLOSE direction.

- Check the function of the closing edge safety device during commissioning.

1. Select menu **F**.  
⇒ After approximately 2 seconds, the display flashes and the set value appears.
2. Adjust the setting using the buttons  .

Value	Closing edge safety device / Radio closing edge safety device
0*	No closing edge function

#### Radio closing edge safety device at input O or P

Value	Safety input 1 (closing edge)	Safety input 2 (wicket door)
1	Optical closing edge safety device	Connection of an ENS-S 8200
2	Optical closing edge safety device	Jumper
3	8k2 Safety contact strip	Connection of an ENS-S 8200
4	8k2 Safety contact strip	Jumper

#### Closing edge safety device at input A



Value	Closing edge safety device
5	8k2 closing edge safety device
6	Optical closing edge safety device
7	8k2 Closing edge safety device (without internal power control when moving to the CLOSE position)
8	Optical closing edge safety device (without internal power control when moving to the CLOSE direction)

\*default setting

3. Press the programming button .  
⇒ The number **E** is displayed.

### 5.8.5 Menu E: Input 1

The setting in this menu determines what happens when a pulse is applied to terminal S (input 1). See also chapter "Connection diagram overview".

1. Select menu **E**.  
⇒ After approximately 2 seconds, the display flashes and the set value appears.
2. Adjust the setting using the buttons  .



Value	Description
0	Move to the OPEN position
1	Move to the CLOSE position
2	Stop the drive
3	Switch on the 4-minute light
4	Block the drive
5*	Single-lane control (in combination with traffic light control) – If the door is OPEN, move to the CLOSE direction, otherwise move to the OPEN direction.
9	Setting personalised via Bluetooth APP

\*default setting

3. Press the programming button .  
⇒ Menu **C** is displayed.

### 5.8.6 Menu o: Input 2

The setting in this menu determines what happens when a pulse is applied to terminal R (input 2). See also chapter "Connection diagram overview".

1. Select menu **o**.  
⇒ After approximately 2 seconds, the display flashes and the set value appears.
2. Adjust the setting using the buttons  .



Value	Description
0*	Move to the OPEN position
1	Move to the CLOSE position
2	Stop the drive
3	Switch on the 4-minute light
4	Block the drive
5	Single-lane control (in combination with traffic light control) – If the door is OPEN, move to the CLOSE direction, otherwise move to the OPEN direction.
9	Setting personalised via Bluetooth APP

\*default setting

3. Press the programming button .  
⇒ Menu **C** is displayed.



### 5.8.7 Menu c: Photoelectric sensor input 2

Terminal C provides a second input for connecting a further photoelectric sensor (2-wire photoelectric sensor). See also chapter "Connection diagram overview". The setting in this menu determines the configuration of the photoelectric sensor.

1. Select menu .  
⇒ After approximately 2 seconds, the display flashes and the set value appears.
2. Adjust the setting using the buttons  .

Value	Description
0*	Photoelectric sensor at input C is not used
1	If the photoelectric sensor is triggered when moving to the CLOSE direction, the door reverses in the OPEN direction. The photoelectric sensor has no influence when moving in the OPEN direction
2	When the photoelectric sensor is triggered in the OPEN direction, the drive stops. The photoelectric sensor has no effect when moving in the CLOSE direction.

\*default setting

3. Press the programming button .  
⇒ Menu  is displayed.

### 5.9 Restoring the factory settings

1. Press the  and  buttons at the same time.

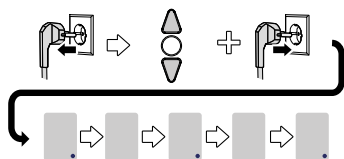



Fig. 8: Factory settings

2. Press both buttons for approximately 3 seconds while pulling out the mains plug from the mains socket and while reinserting the mains plug again.



The hand-held transmitters are not deleted when using this function. To delete the hand-held transmitters, please follow the instructions in chapter "Deleting all hand transmitters programmed for the drive".

### 5.10 Cycle counter

The cycle counter stores the number of OPEN/CLOSE actions powered by the drive. To read the meter, hold the button  at the drive head pressed for 3 seconds until you see a figure.

The digital display shows the numbers starting from the highest to the lowest decimal place consecutively. At the end of the digit sequence, a horizontal line appears on the display, for example:

3456 movements, 3 4 5 6 -.

## 6 Initial operation

In order to ensure safe and trouble-free functioning of the door drive it is essential that all parts have been mounted in accordance with the assembly instructions. After having completed the assembly and programming check the garage door drive as well as the garage door for safe and proper functioning by executing all operating functions. If it was possible to execute all operating functions perfectly and all safety devices are working properly, the garage door drive is ready for operation.

Proceed as follows to check a possibly available wicket door contact: Open the wicket door when the drive is switched on. The display shows the value .

Furthermore, observe the following commissioning instructions:

- The installer must fill out the commissioning report (see "Check lists" chapter) completely and give it to the operating company / owner before the operating company / owner puts the system into service. This recommendation includes manually operated doors.
- The operating company / owner is obliged to store the commissioning report as well as the proof of inspection and maintenance of the door system (see "Check lists" chapter) together with the documentation for the garage door drive for the entire service life of the system.
- Modifications or changes to the garage door drive must be permitted by the manufacturer. Alterations to the garage door drive (in as far as permitted) must also be documented.
- Ensure that the ball handle is located 1.80 m max. above the floor so that it can be reached.

## 7 Operation

### 7.1 Safety instructions for operation

Observe the following safety information for operation:

- All operators must be instructed on the handling and be familiar with the applicable safety regulations.
- Comply with the accident prevention regulations and general safety regulations relevant to the field of application.
- Keep hand-held transmitters out of reach of children.

#### **WARNING**



#### **Impact and crush hazard due to the door movement!**

The opening and closing processes must be monitored.



- The garage door must be visible from the place of operation.
- Make sure that no persons or objects are in the travel path of the garage door.

### 7.2 Opening or closing the garage door (in normal operation mode)

The garage door can be operated by different devices (hand-held transmitter, key switch etc.). These assembly and operating instructions only refer to the control via hand-held transmitter. Other devices work in the same way.

1. Briefly press the button on the hand-held transmitter once. Depending on the current position, the garage door moves to the OPEN or CLOSE position.
2. If needed, briefly press the button on the hand-held transmitter to stop the movement of the garage door.
3. If needed, press the button on the hand-held transmitter once again to make the garage door move in the other direction.



A button on the hand-held transmitter can be set with the "light function". By using the hand-held transmitter the light will be turned on, independently from the drive unit. After 4 minutes the light will be turned off.

### 7.3 Manually opening or closing the garage door

#### **WARNING**



#### **Impact and crush hazard due to uncontrolled door movement!**



When moving the door by hand (with the drive decoupled), it can move in an uncontrolled fashion, especially when the setting is incorrect or the door springs are defective.

- Contact the responsible supplier/manufacturer if you see that the door is not balanced correctly.

#### **NOTICE**

In the process of installing the system, locking elements of the garage door have been dismantled. They should be reinstalled if the garage door is to be operated manually over a longer period of time. This way the garage door can be locked when closed.

#### **NOTICE**

The ball handle must be located 1.80 m max. above the floor.

During adjustments to the garage door, or during power failure, the garage door can be manually opened or closed.

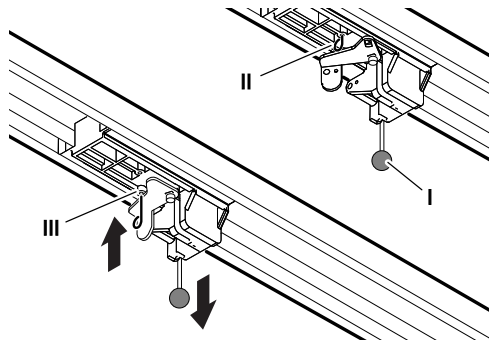

Fig. 9: Disengaging and engaging the drive

To move the garage door, manually pull on the pull cord (I) on the carriage and detach the carriage from the toothed belt or chain. The garage door can now be moved manually.

To operate the gate manually for a longer period of time, you can insert the locking pin (II) into the carriage (III) in the bore provided for this purpose. To restore normal operation, loosen the locking pin (II).

## 7.4 Moving the garage door specifically into the OPEN or CLOSE position (further operating modes)

### 7.4.1 Moving the garage door into the OPEN position

There is the possibility of moving the door specifically into the direction of the OPEN position by means of a hand-held transmitter or the APP.

- When the door is in the lower end position or in an intermediate position, an OPEN command makes the door move into the direction of the upper end position.
- When the door is in the upper end position or moving into the upper end position, an OPEN command has no impact.
- When the door is moving into the direction of the lower end position, an OPEN command makes the door stop briefly to move back to the OPEN direction.

### 7.4.2 Moving the garage door into the CLOSE position

There is the possibility of moving the door specifically into the direction of the CLOSE position by means of a hand-held transmitter or the APP.

- When the door is in the upper end position or in an intermediate position, a CLOSE command makes the door move into the direction of the lower end position.
- When the door is in the lower end position or moving into the lower end position, a CLOSE command has no impact.
- When the door is moving into the direction of the upper end position, a CLOSE command makes the door stop.

## 7.5 Determining the radio module type

### **⚠ DANGER**



#### **Hazardous voltage!**

Fatal electric shock when touching live parts.

Always pull out the mains plug before working on the drive!

Provided a radio module is installed, you can determine the used radio frequency as follows:

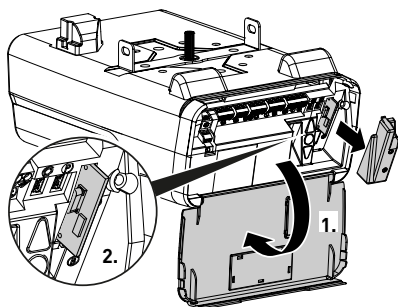

Fig. 10: Opening the drive head cover and determining the radio module type

1. Open the service flap on the drive head.
2. Remove the cover.
3. Determine the radio frequency as specified on the type designation on the label of the radio module and the corresponding data in the chapter "Technical data".



Fig. 11: Label with type designation of radio module

4. Replace the cover.
5. Close the service flap on the drive head.

## 8 Errors and faults

### 8.1 Troubleshooting

#### WARNING



#### Impact and crush hazard due to uncontrolled door movement!

During troubleshooting, when the drive is decoupled or if the door springs are damaged, the door can carry out uncontrolled movements.



- Always pull out the mains plug before working on the drive!
- Secure the door against uncontrolled movements.











Malfunction	Possible causes	Remedy
Door does not fully open / close.	Door mechanics have changed.	Have the door checked.
	Closing / opening force is set too low.	Correct the force settings, see chapter "Menu 5 + 6".
	End position is set incorrectly.	Have the end position reset.
After closing, the door opens again slightly.	Door blocks just before reaching the closed position.	Remove the obstruction.
	End position is set incorrectly.	Have the end position CLOSE reset.
Drive does not move although the motor is running.	Drive is disengaged.	Re-engage the drive, see chapter "Manually opening or closing the garage door".
Door does not respond to hand-held transmitter pulses, but to pulses from push buttons or other pulse generators.	Hand-held transmitter battery is empty.	Replace the hand-held transmitter battery.
	Antenna is missing or misaligned.	Plug in / align the antenna.
	No hand-held transmitter programmed.	Program the hand-held transmitter, see "menu 1".
Door responds neither to hand-held transmitter pulses nor to other pulse generators.	See diagnostic display.	See diagnostic display.
Insufficient range of hand-held transmitter.	Hand-held transmitter battery is empty.	Replace the hand-held transmitter battery.
	Antenna is missing or misaligned.	Plug in / align the antenna.
	On-site shielding of reception signal.	Connect the external antenna (accessory).
Toothed belt or drive are noisy.	Toothed belt is dirty.	Clean the toothed belt. Spray with silicone spray (Do not use oil-containing substances).
	Toothed belt is tensioned too tightly.	Relieve the toothed belt of tension.















#### NOTICE

#### Defect on the power supply line

If the power supply line of this product is damaged, it must be replaced by the manufacturer or its customer service or a similarly qualified person in order to prevent risks.

## 8.2 Diagnostic display

Value	State	Diagnosis/remedy
	Garage door opens.	
	Garage door has reached end position OPEN.	
	Garage door closes.	
	Garage door has reached end position CLOSE.	
	Garage door is between end positions OPEN and CLOSE.	
	Garage door is in ventilation position.	
	Display shows a "0" during the next opening and closing cycle and then goes out.	The drive is carrying out a learning cycle for the force limit. Caution: During this travel cycle the drive does not monitor the force.
	Display continues to show a "0".	The force learning cycle has not been completed and must be repeated. Possibly, the resistance in one of the end positions is too high. Reset the end positions.
	Door does not open or close.	Interruption at connection STOP-A or activation of the external safety device (e.g. wicket door).
	Door does not close.	Interruption at connection STOP-B or activation of the external safety device (e.g. photoelectric sensor).
	Door setting and learning cycle have not been completed correctly.	You must use menus 3 and 4 to correct the door settings and then complete the force learning cycle.

Value	State	Diagnosis/remedy
	Permanent signal at the input of connection terminal F.	Start signal is not detected, or continuous pulse (e.g. button jammed).
	The distance set is too long.	Set a new distance in menus 3 and 4.
	Closing edge safety device has tripped.	Check the closing edge safety device and the wiring on the radio closing edge. Check the settings in menu F.
	The drive path set is too short.	Set the drive path in menus 3 and 4 again.
	Emergency release or wicket door contact has been activated.	Re-engage the motor head or check the wicket door contact.
	Internal error	An error has occurred during the self-test. Pull out the mains plug, then plug it back in after approx. 10 seconds.
	End position monitoring function has detected an authorised opening attempt in CLOSE end position.	The message is deleted with the next regular drive.
	Test of the photoelectric sensor (input H/G or C) failed	Check the photoelectric sensor and the wiring of the photoelectric sensor.
	Motor standstill.	The motor does not rotate. Call a specialist company to repair the motor.
	Electronic brake activated. The garage light remains on.	The operator is pulled from upper end position. Check the door and the springs. Set a lower upper end position.
	The wicket door contact test failed.	Check the cables and clamping connections of the wicket door contact.
	Fault at the photoelectric sensor	Check the wiring of the photoelectric sensor.
	Vacation lock is activated. Door does not open.	Set the slide switch for SafeControl/Signal 112 (accessory) back to the ON position.
	Switch-on limit active.	Wait a few minutes until the switch-on limit is automatically deactivated.

## 9 Maintenance / checks

### 9.1 Notes on maintenance / checks

#### **DANGER**



#### **Hazardous voltage!**

Fatal electric shock when touching live parts.

Always pull out the mains plug before working on the drive!

#### **NOTICE**

For your safety, we recommend that the door system be checked as needed – however, at least once a year – in accordance with the check list of the door system in the “Check lists” chapter. The check can be carried out by a person with the corresponding qualification certificate or by a specialist company.

#### **NOTICE**

After an inspection, the user must do any necessary maintenance.

- All inspection and maintenance activities are to be documented in the supplied proof of inspection and maintenance of the door system (see “Check lists” chapter).
- The manufacturer’s specified inspection and maintenance intervals must be observed.
- The manufacturer’s guarantee becomes null and void in the event that the specified inspection/maintenance activities have not been carried out properly.
- Modifications or changes to the garage door drive must be permitted by the manufacturer. Alterations to the garage door drive (in as far as permitted) must also be documented.

### 9.2 Monthly monitoring the force limits

In an end position or after restarting, the integrated power disconnection is tested automatically.

#### **WARNING**



#### **Crush hazard at the door!**

If the force limits are set too high, there is a risk of personal injury.



- The force on the main closing edge must not exceed 400 N for a maximum of 750 ms!

Check the force limits every month as described in chapter “Checking the force limits” and document them in accordance with Proof of inspection and maintenance of the door system.

## 9.3 Check lists

### 9.3.1 Commissioning report

Owner / operating company of the system:	
--	--

Location of door system:	
--------------------------	--

#### Drive data

Manufacturer:	
---------------	--

Drive type:	
-------------	--

Operating mode:	
-----------------	--

Manufacture date:	
-------------------	--

#### Door data

Type:	
-------	--

Serial no.:	
-------------	--

Year of construction:	
-----------------------	--

Door dimensions:	
------------------	--

Door leaf weight:	
-------------------	--

#### Installation and initial operation

Company, installer:	
---------------------	--

Name, installer:	
------------------	--

Initial operation on:	
-----------------------	--

Signature:	
------------	--

#### Other:

#### Changes:

### 9.3.2 Check list for door system

Confirm features/checks at start-up with a check mark.

No.	Equipment	Present?	Features to be tested	Note
1.0	<b>Garage door</b>			
1.1	Manual opening and closing		Smooth running	
1.2	Fastenings / connections		State / seat	
1.3	Pivots / joints		State / lubrication	
1.4	Track rollers / track roller holders		State / lubrication	
1.5	Seals / sliding contact strips		State / seat	
1.6	Door frame / door guide		Alignment / fastening	
1.7	Door leaf		Alignment / state	
2.0	<b>Weight</b>			
2.1	Springs		State / seat / setting	
2.1.1	Spring strips		State	
2.1.2	Spring break device		State / rating plate	
2.1.3	Safety elements (spring connector,...)		State / seat	
2.2	Wire cables		State / seat	
2.2.1	Mounting		State / seat	
2.2.2	Cable drum			
2.3	Fall protection		State	
2.4	Concentricity of T-shaft		State	
3.0	<b>Drive / control</b>			
3.1	Drive / rail / bracket			
3.2	Electrical cables / connections			
3.3	Emergency release		Function / state	
3.4	Control devices, push buttons / hand-held transmitters		Function / state	
3.5	Limit stop		State / position	
4.0	<b>Safeguarding of crush and shearing zones</b>			
4.1	Force limit		Stops and reverses	
4.2	Protection against lifting of persons		Door leaf stops at 20 kg	
4.3	Site conditions		Safely distances	
5.0	<b>Other equipment</b>			
5.1	Latching / lock		Function / state	
5.2	Wicket door		Function / state	
5.2.1	Wicket door contact		Function / state	
5.2.2	Door closer		Function / state	
5.3	Traffic light control		Function / state	
5.4	Photoelectric sensors		Function / state	
5.5	Closing edge safety device		Function / state	
6.0	<b>Documentation of the operator / owner</b>			
6.1	Rating plate / CE marking		complete / readable	
6.2	Door system's Declaration of Conformity		complete / readable	
6.3	Installation, Operation and Maintenance Instructions		complete / readable	

### 9.3.3 Proof of inspection and maintenance of the door system

Date	Work performed / necessary measures	Test carried out	Defects rectified
		Signature / company address	Signature / company address

## 10 Cleaning / care

### DANGER



#### Hazardous voltage!

If the drive comes into contact with water, there is a risk of electric shock!

Do not use any water or liquid detergent for cleaning.

### WARNING



#### Impact and crush hazard due to inadvertent door movement!

When cleaning the control unit, inadvertent movement of the door may be activated.



- Disconnect the control unit from the mains by pulling out the mains plug.

If necessary, wipe the drive with a dry cloth.

## 11 Disassembly / disposal

### 11.1 Disassembly

Disassembly is carried out in reverse order of the assembly instructions in the **Installation** chapter.

### 11.2 Disposal

For disposal, disassemble the door system and separate it into its individual material groups:

- plastics
- non-ferrous metals (e.g. copper scrap)
- electric scrap (motors)
- steel

Dispose of all materials according to the national legislation! Dispose of packaging material in an environmentally friendly way and in accordance with the applicable local disposal regulations.



The symbol with the crossed-out waste bin on waste electrical or electronic equipment stipulates that this equipment must not be disposed of with the household waste at the end of its life. You will find collection points for free return of waste electrical and electronic equipment in your vicinity. The addresses can be obtained from your municipality or local administration. The separate collection of waste electrical and electronic equipment aims to enable the re-use, recycling and other forms of recovery of waste equipment as well as to prevent negative effects for the environment and human health caused by the disposal of hazardous substances potentially contained in the equipment.



In the European Union, batteries and accumulators must not be treated as domestic waste, but must be disposed of professionally in accordance with Regulation (EU) 2023/1542 of the European Parliament and of the Council of 12 July 2023 concerning batteries and waste batteries. Please dispose of batteries and accumulators according to the relevant legal requirements.

### UK (The following applies for the United Kingdom)

According to Waste Electrical and Electronic Equipment Regulations 2013 (2013/3113) electronic devices that are no longer usable must be collected separately and disposed of in an environmentally friendly manner.

## 12 Warranty terms

The warranty is valid for 2 years or 50000 cycles (whichever is reached first). The full text of the warranty terms can be found at:

<https://www.tormatic.de/garantiebestimmungen>

## 13 Declaration of conformity and incorporation

### 13.1 Declaration of Incorporation in accordance with the EC Machinery Directive 2006/42/EC

#### Manufacturer's Declaration of Incorporation (Translation of the Original)

For the installation of partly completed machinery in terms of the EC Machinery Directive 2006/42/EC, Annex II Part 1 Section B We hereby declare that the following partly completed machinery – as far as possible with respect to the scope of supply – complies with the essential requirements of the EC Machinery Directive. The partly completed machinery is only intended to be incorporated into a door system to thus form a complete machine within the meaning of the EC Machinery Directive. The door system must not be put into service until the final machinery has been declared in conformity with the provisions of the EC Machinery Directive and the EC Declaration of Conformity according to Annex II A is available. We furthermore declare that the relevant technical documentation for this partly completed machinery has been compiled in accordance with Annex VII, Part B, and undertake to transmit it through our Documentation Department in response to a reasoned request by the competent national authorities.

Product model / product: B-1204

Product type: Garage door drive

Year of manufacture from: 05/2025

Relevant EC/EU directives: 2014/30/EU  
2011/65/EU RoHS Directive including Annex II according to (EU) 2015/863

Fulfilled requirements of the EC Machinery Directive 2006/42/EC, Annex I, Part 1: 1.1.2, 1.1.3, 1.1.5, 1.2.1, 1.2.2, 1.2.3, 1.2.4, 1.2.5, 1.2.6, 1.3.2, 1.3.4, 1.5.1, 1.5.4, 1.5.5; 1.5.6, 1.6.1, 1.6.2, 1.6.3; 1.7

Applied harmonised standards: EN ISO 12100:2010;  
EN ISO 13849-1:2015, PL "C" Cat. 2;  
EN 60335-1:2012/A15:2021;  
EN 60335-2-103:2015;  
EN 61000-6-3:2007/A1:2011;  
EN 61000-6-2:2005/AC:2005;  
EN 61000-6-4:2007/A1:2011;  
EN 12453:2017+A1:2021;  
EN 300 220-2 V3.1.1

Other applied technical standards and specifications: EN 300220-1:2017;  
EN 301489-1 V2.1.1

Manufacturer and name of the authorised representative of the technical documentation: Novoferm tormatic GmbH  
Eisenhüttenweg 6  
44145 Dortmund

Place and date of issue: Dortmund, 30.09.2025



Managing Director, Christian Hasenest

### 13.2 Declaration of Conformity according to Directive 2014/53/EU

The optional radio system complies with directive 2014/53/EU. The full text of the declaration of conformity can be found at:  
<https://www.tormatic.de/dokumentation/>



**Novoferm tormatic GmbH**

Eisenhüttenweg 6

44145 Dortmund

[www.tormatic.de](http://www.tormatic.de)